

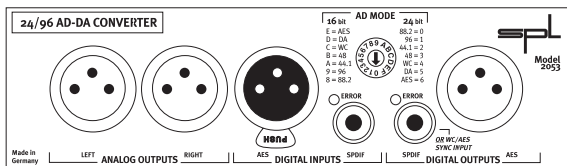

Manual



24/96 AD-DA Converter

Model 2053

Version 1.0 – 8/2000

The information in this document has been carefully verified and is assumed to be correct. However Sound Performance Lab (SPL) reserves the right to modify the product described in this manual at any time. Changes without notice. This document is the property of SPL and may not be copied or reproduced in any manner, in part or full without the authorization of SPL.

Limitations of Liability:

In no event will SPL be liable for any damages, including loss of data, lost profits, cost of cover or other special, incidental, consequential or indirect damages arising from the use of the unit, however caused and on any theory of liability. This limitation will apply even if SPL or an authorized dealer has been advised of the possibility of such damage.

Sound Performance Lab
P.O. Box 12 27
D- 41368 Niederkruechten, Germany
Phone +49 - 21 63 / 98 34-0
Fax +49 - 21 63 / 98 34-20
eMail: info@soundperformancelab.com
www.soundperformancelab.com

© 2000 SPL electronics GmbH. All Rights Reserved.

Contents

Security Advises	4
Product Description	4
Mounting	
General Information	5
Steps 1 and 2	6
Steps 3 and 4	7
Connections	8
Analog XLR Outputs	8
Digital I/Os	9
Operation	
Scope of Functions	9
AD MODE Switch	10
ERROR-LEDs	10
External Synchronization	11
Applications	
Channel One: Using both converters	12
Ch. One: Using both channels of the converter	12
24Bit/96 kHz Monitoring	13
Analog processing of a digital signal	13
Example 1: Processing a sampler's signal	14
Example 2: Recording on a DAT Recorder	14
Specifications	15
Block Diagram	16
Measurements	17
Warranty	19

Security Advices

- Please consider referring the installation of the unit operating the converter the safety information in the corresponding operation instruction.
- Please carry out the self-installation only as described from page 5. In case of queries please contact an expert.

Product Description

The SPL converter module 2053 combines separately useable A/D and D/A converters, with a wordwidth up to 24 Bits, and a Sample-rate of up to 96 kHz.

The D/A converter processes up to 24 Bits automatically, as well as sample-rates from 32Bit to 96 kHz and is equipped with high-quality, balanced XLR outputs (+ 12 dBu).

The A/D converter supports 16 and 24Bit formats and works. The reduction from 24Bit to 16Bit is processed with the Dithering-method: the "missing" lower 8Bit is not cut off, but rather "included" in the 16 Bit format. This ensures that quietest passages are preserved.

Internal Synchronization: The converter module allows to choose 5 different clock sources via the AD MODE switch. The internal sample rates (96 kHz/48 kHz and 88.2 kHz/44.1 kHz) are Quartz-generated.

Product Description

External synchronization: For synchronization with external sources, AES-data or Word-Clock signals can be used as sync sources. Alternatively the A/D converter can be synchronized to the data adjacent to the D/A converter. For internal/external synchronization please refer to the chapter "Operation", from page 11.

General Information

Mounting

The SPL converter module 2053 is exclusively offered as an option for certain SPL units. We especially advise electronically inexperienced users to contact an expert in case of queries.

- In order to avoid static loads, please deactivate the GND-Lift switch on the back of the unit that is to be upgraded and touch its case.
- Now pull the power cord out of the socket on the back of the unit operating the converter module. Please also remove all other cable connections.
- Treat the converter carefully. Please make sure that you only touch the front panel or the sides of the circuit board in order to avoid contact with parts on the circuit board. Never force any parts when connecting unit and converter module.

Step 1: Please put the converter module as illustrated on the unit top and remove the screws of the cover from the back of the upgrade unit.

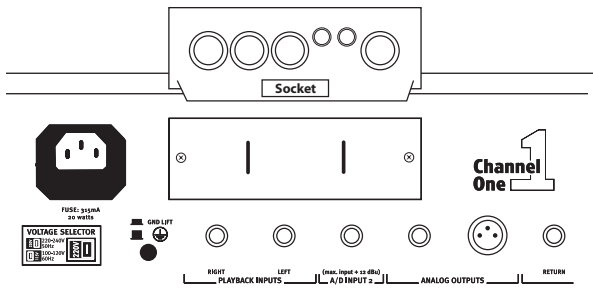

Step 2: Please remove the mounting of the wiring on the back of the cover (eventually cut off the silicon).

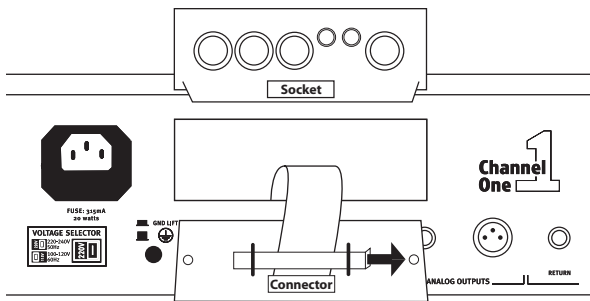

Steps 3 and 4

Mounting

Step 3: Connect the cable carefully, without turning, to the socket of the converter. Guideways on socket and plug exclude a wrong connection.

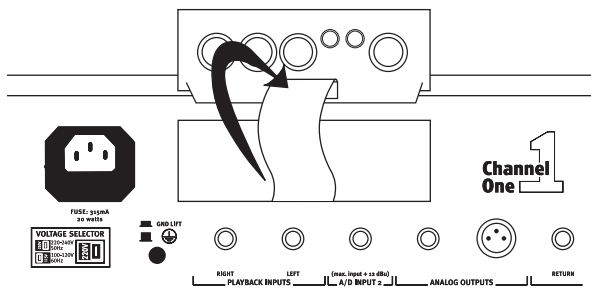

Step 4: Put the converter, as illustrated, without lateral turning in the unit (circuit board above, connection sockets on the head) and connect it with the screws of the cover. The converter is now operational.

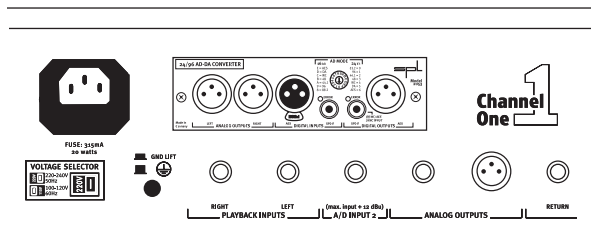

Connections

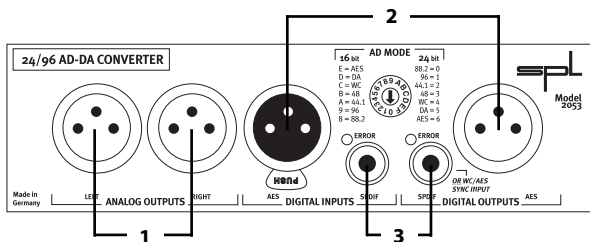

The converter module provides analog, balanced XLR outputs (1), digital XLR I/Os (AES/EBU) (2) and digital S/P-DIF I/Os (3). In case of using the S/P-DIF output as a WC/AES SYNC input, the S/P-DIF output is no longer available. **Important:** please never use AES- and S/P-DIF digital inputs simultaneously!

Analog XLR Outputs



Wiring XLR Output
1 = GND, 2 = hot (+), 3 = cold (-)

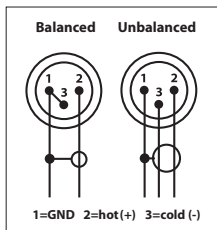

The unit operating the module has to be switched off

before connecting the converter via the XLR outputs with other units.

The illustration to the left demonstrates the correct wiring for unbalanced operation.

Digital I/Os

AES/EBU: Inputs and outputs according to the AES/EBU specification for the connection of all digital units specified in accordance to AES/EBU.

S/P-DIF: Alternatively to the digital XLR-sockets, the S/P-DIF I/Os can be used for the connection of digital units. The S/P-DIF output (=WC/AES SYNC INPUT) can also be used for external synchronization via external clocks (refer to "Applications, external synchronization" on page 11).

Scope of Functions

Operation

In contrast to usual concepts, the SPL converter 2053 comprises separate A/D and D/A converter stages. First of all the converter is determined for the optional equipping of the SPL CHANNEL ONE (mono channel strip). The possible applications generally described concern all future SPL units which are determined for the recording of the converter. Equipping both converter stages offers two essential advantages:

- High-quality monitoring in 24Bit/96kHz quality with simultaneous A/D conversion
- Analog processing of a digital signal

Operation

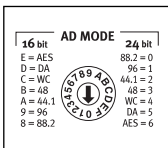

AD MODE Switch

The AD MODE switch is used to set the desired bit mode and sample rate. The following list explains the respective switch positions:

16 Bit Mode

- E = AES Ext. Synchronization to AES clock
- D = DA Synchronization zum D/A converter
- C = WC Ext. Synchronization to word clock
- B = 48 Int. Synchronization to 48 kHz
- A = 44,1 Int. Synchronization to 44,1 kHz
- 9 = 96 Int. Synchronization to 96 kHz
- 8 = 88,2 Int. Synchronization to 88,2 kHz

24 Bit Mode

- 0 = 88,2 Int. Synchronization to 88,2 kHz
- 1 = 96 Int. Synchronization to 96 kHz
- 2 = 44,1 Int. Synchronization to 44,1 kHz
- 3 = 48 Int. Synchronization to 48 kHz
- 4 = WC Ext. Synchronization to word clock
- 5 = DA Synchronization to D/A converter
- 6 = AES Ext. Synchronization to AES clock

Error LEDs

The Error-LEDs indicate faulty audio signals at the S/P-DIF input or faulty sync signals at the WC/AES SYNC INPUT (=S/P-DIF output). In this case the respective signal is muted.

External Synchronization

External Synchronization (Connection via W/C-AES SYNC INPUT) is required when several signals must be brought together within a chain of digital units, e.g. when connecting several digital units at one console. Since the sample frequencies are never exactly identical, not synchronized sample rates inevitably have different timings - samples are ignored or read twice, usually audible als cracking.

By supplying all signal sources with a common frequency, all signals are synchronized and sample faults are avoided.

The common frequency can either be transmitted via unbalanced coaxial wiring using a BNC/CINCH adapter as Word/House Clock or as AES data if connected as shown in the graphic below. In both cases the WC/AES SYNC INPUT is to be used.

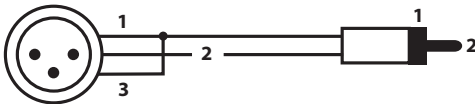

AES XLR Connector

1 = GND, 2 = Signal,
3 = Signal to GND (3 to 1)

Cinch

1 = Sleeve
2 = Tip

Applications

CHANNEL ONE: Using both converters

Referring to the CHANNEL ONE, the separate use of both converters can be for example the conversion of digital signals independent from the A/D converter and to reproduce them in best tonal quality on loudspeakers or headphones.

Example: High-quality conversion of a digital console's output signal.

Another application is the high-end conversion of digital signals for the further analog processing (refer to "Operation, analog processing of a digital signal", page 13).

CHANNEL ONE: Using both channels of the converter

The CHANNEL ONE is a mono unit. Consequently only one channel of the A/D converter can be used with it. Since A/D converters usually are designed as stereo units with two channels, it is possible to convert a second mono signal via the A/D INPUT 2 on the CHANNEL ONE. If this socket is not in use, the A/D-Converter routes the mono signal of the CHANNEL ONE to both channels.

Example: During a voice recording with the CHANNEL ONE, a guitar signal can be converted at the same time.

Monitoring in 24Bit/96kHz

A high standard of monitoring is necessary for judging the recording quality. Therefore all digital signals have to be converted into analog signals to allow reproduction on loudspeakers or headphones.

The A/D converter stage is equipped with high-quality components and ensures excellent tonal results. We recommend to use the SPL converter rather than the converters found in DAT recorders, sound cards or digital consoles.

Analog processing of a digital signal

Together with the converter module, the inputs of the CHANNEL ONE can also be used for digital signals to have access to the entire processing bandwidth including the tube pre-amplifier.

Please consider the following instructions: the sockets INSTR. IN (front) and LINE (back) need not be occupied. The MIC/LINE switch has to be set to LINE. The converter signal is now routed to the preamplifying stage of the CHANNEL ONE.

The LINE socket is a switch socket - a signal connected to the LINE socket takes priority, otherwise the converter signal will be connected through.

Applications

Example 1: Processing a sampler's signal

Connect the output of the sampler via AES/EBU or S/P-DIF interface with the input of the converter. The adjustment described in the section above now allows to process the sampler's signal. If the processed signal is to be returned digitally converted to the sampler, the A/D converter has to be synchronized to the D/A converter (= external synchronization; the D/A converter is the source clock for the A/D converter). In this case, please set the AD MODE switch on the converter module to position "5" (24 Bit) or "D" (16 Bit).

Example 2: Recording on a DAT recorder

If the processed signal is to be recorded on a DAT recorder, the best Bit-format of the DAT-recorder must be chosen on the AD MODE switch (16 or 24 Bit), while the internal synchronization should be adapted to the desired sample rate. For 16 Bit operation choose one of the switch positions B, A, 9 or 8, for 24 Bit 0, 1, 2, or 3. Unless a House-Clock controls all digital units: in this case please set the AD MODE switch to position C for 16 Bit or 4 for 24Bit (compare chapter "Operation, internal and external synchronization", page 11).

Specifications

A/D Converter

Wordwidth	24 Bit
Reduced Wordwidth	16 Bit
Dither	triangular
Internal sample rates	44.1/48/88.2/96 kHz
External sample rates	32-96 kHz
Sync sources	AES 11 or word clock
THD+N @-1 dBFs, 1 kHz	<-101 dB
Dynamic range (A)	110 dB

D/A Converter

Wordwidth	24Bit
Sample rates	32-96 kHz
THD+N (@-1 dBFs, 1 kHz)	<-90 dB
Dynamic range (A, Q 96 kHz) ...	105 dB

Block Diagram

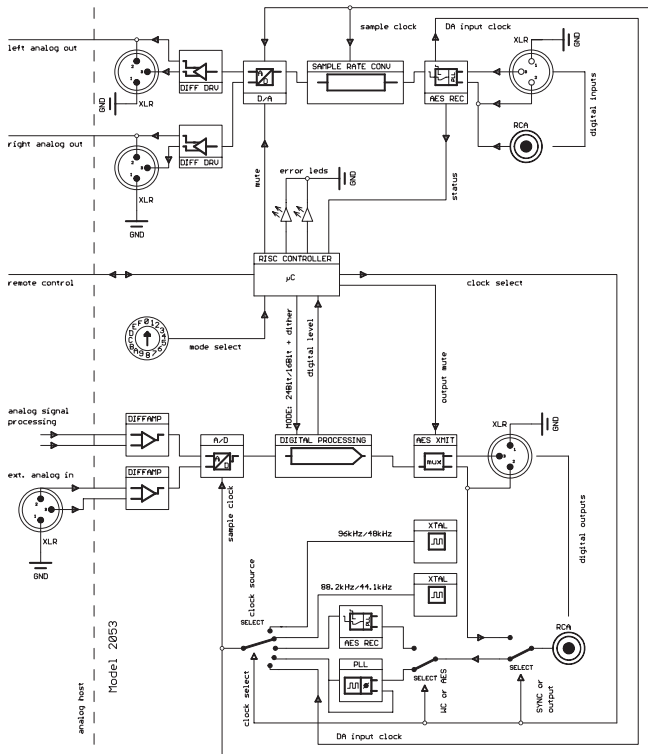

Measurements

D/A: THD&N above input level

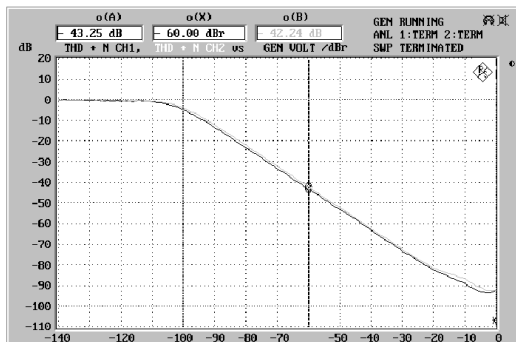

D/A: THD&N @ 1 kHz FFT

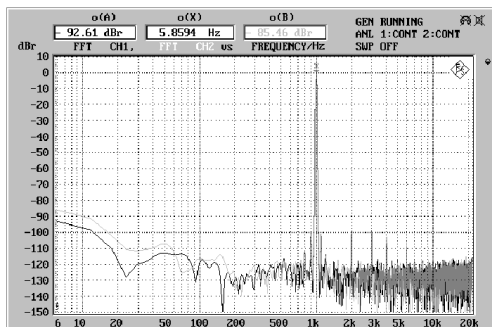

Measurements

A/D: THD&N above input level

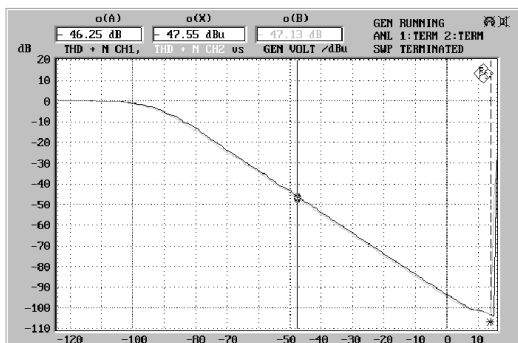

A/D: THD&N @ 1 kHz FFT

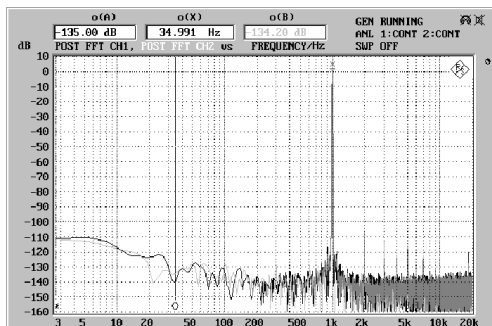

Warranty

SPL electronics GmbH (hereafter called SPL) products are warranted only in the country where purchased, through the authorized SPL distributor in that country, against defects in material or workmanship. The specific period of this limited warranty shall be that which is described to the original retail purchaser by the authorized SPL dealer or distributor at the time of purchase.

SPL does not, however, warrant its products against any and all defects:

1) arising out of materials or workmanship not provided or furnished by SPL, or 2) resulting from abnormal use of the product or use in violation of instructions, or 3) in products repaired or serviced by other than authorized SPL repair facilities, or 4) in products with removed or defaced serial numbers, or 5) in components or parts or products expressly warranted by another manufacturer.

SPL agrees, through the applicable authorized distributor, to repair or replace defects covered by this limited warranty with parts or products of original or improved design, at its option in each respect, if the defective product is shipped prior to the end of the warranty period to the designated authorized SPL warranty repair facility in the country where purchased, or to the SPL factory in Germany, in the original packaging or a replacement supplied by SPL, with all transportation costs and full insurance paid each way by the purchaser or owner.

All remedies and the measure of damages are limited to the above services. It is possible that economic loss or injury to person or property may result from the failure of the product; however, even if SPL has been advised of this possibility, this limited warranty does not cover any such consequential or incidental damages. Some states or countries do not allow the limitations or exclusion of incidental or consequential damages, so the above limitation may not apply to you.

Any and all warranties, express or implied, arising by law, course of dealing, course of performance, usage of trade, or otherwise, including but not limited to implied warranties of merchantability and fitness for particular, are limited to a period of 1 (one) year from either the date of manufacture. Some states or countries do not allow limitations on how long an implied warranty lasts, so the above limitations may not apply to you.

This limited warranty gives you specific legal rights, and you may also have other rights which vary from state to state, country to country.

SPL electronics GmbH, 41372 Niederkruechten, Germany



Sound Performance Lab
Sohlweg 55
D-41372 Niederkruechten
Germany

Tel. +49 • 2163 • 9834-0, Fax -20
info@soundperformancelab.com
www.soundperformancelab.com

24/96 AD-DA Converter, Model 2053